



# PD55003L-E

## RF POWER TRANSISTOR *The LdmoST Plastic FAMILY*

### General features

- Excellent thermal stability
- Common source configuration
- $P_{OUT} = 3W$  with 17dB gain@500MHz/12.5V
- New leadless plastic package
- ESD protection
- Supplied in tape & reel of 3K units
- In compliance with 2002/95/EC european directive

### Description

The PD55003L-E is a common source N-Channel, enhancement-mode lateral Field-Effect RF power transistor. It is designed for high gain, broadband commercial and industrial application. It operates at 12V in common source mode at frequencies of up to 1GHz. PD5500L-E boasts the excellent gain, linearity and reliability of STH1LV latest LD-MOS technology mounted in the innovative leadless SMD plastic package, PowerFLAT™.

PD5500L-E's superior linearity performances makes it an ideal solution for car mobile radio.

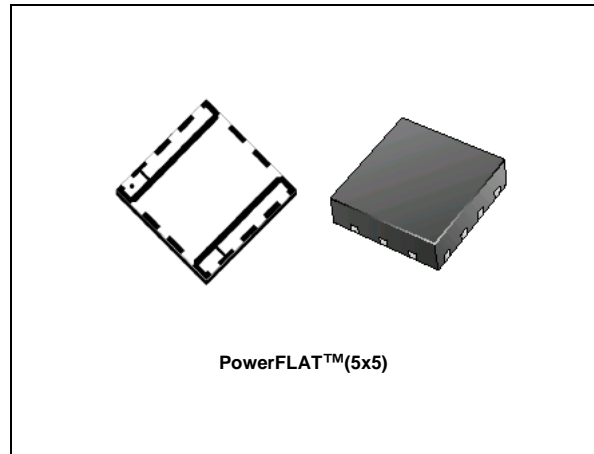

### PIN configuration

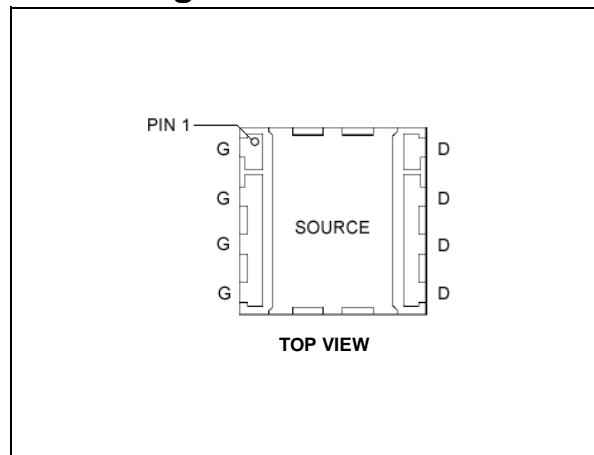

### Order codes

Sales Type	Marking	Package	Packaging
PD55003L-E	55003	PowerFLAT™(5x5)	TAPE & REEL

## Contents:

<b>1</b>	<b>Electrical data</b> .....	<b>3</b>
1.1	Maximum Ratings .....	3
1.2	Thermal data .....	3
<b>2</b>	<b>Electrical specification</b> .....	<b>4</b>
2.1	Typical performances .....	6
2.2	Typical performance ( <i>broadband</i> ) .....	8
<b>3</b>	<b>Test circuit schematic</b> .....	<b>9</b>
3.1	Test Circuit .....	10
3.2	Test circuit photomaster .....	10
<b>4</b>	<b>Package mechanical data</b> .....	<b>14</b>
<b>5</b>	<b>Revision history</b> .....	<b>18</b>

# 1 Electrical data

## 1.1 Maximum Ratings

Table 1. Absolute maximum ratings ( $T_{CASE}=25^{\circ}C$ )

Symbol	Parameter	Value	Unit
$V_{(BR)DSS}$	Drain-Source Voltage	40	V
$V_{GS}$	Gate-Source Voltage	-0.5 to +15	V
$I_D$	Drain Current	2.5	A
$P_{DISS}$	Power Dissipation (@ $T_C = 70^{\circ}C$ )	14	W
$T_{stg}$	Storage Temperature	- 65 to +150	$^{\circ}C$
$T_j$	Operating Junction Temperature	150	$^{\circ}C$

## 1.2 Thermal data

Table 2. Thermal data

Symbol	Parameter	Value	Unit
$R_{th(j-c)}$	Junction-Case Thermal Resistance	5.7	$^{\circ}C/W$

## 2 Electrical specification

( $T_{CASE}=25^{\circ}C$ )

**Table 3. Static**

Symbol	Test Conditions	Min.	Typ.	Max.	Unit
$I_{DSS}$	$V_{GS}=0V, V_{DS}=28V$			1	$\mu A$
$I_{GSS}$	$V_{GS}=20V, V_{DS}=0V$			1	$\mu A$
$V_{GS(Q)}$	$V_{DS}=10V, I_D=50mA$	2.0		5.0	V
$V_{DS(ON)}$	$V_{GS}=10V, I_D=0.5A$			0.36	V
$g_{fs}$	$V_{DS}=10V, I_D=1A$		1.0		mho
$C_{iss}$ $C_{oss}$ $C_{rss}$	$V_{GS}=0V, V_{DS}=12.5V, f=1MHz$		34 23 1.8		pF pF pF

**Table 4. Dynamic**

Symbol	Test Conditions	Min.	Typ.	Max.	Unit
$P_{1dB}$	$V_{DD}=12.5V, I_{DQ}=50mA, f=500MHz$	3			W
$G_P$	$V_{DD}=12.5V, I_{DQ}=50mA, P_{OUT}=3W, f=500MHz$	17	19		dB
$\eta_D$	$V_{DD}=12.5V, I_{DQ}=50mA, P_{OUT}=3W, f=500MHz$	50	52		%
Load mismatch	$V_{DD}=12.5V, I_{DQ}=50mA, P_{OUT}=3W, f=500MHz$	20:1			VSWR

**Table 5. Switching on/off (inductive load)**

Test Conditions	Class
Human Body Model	2
Machine Model	M3

**Table 6. Switching energy (inductive load)**

Test Methodology	Rating
J-STD-020B	MSL 3

Figure 1. Typical Input/Drain load Impedances

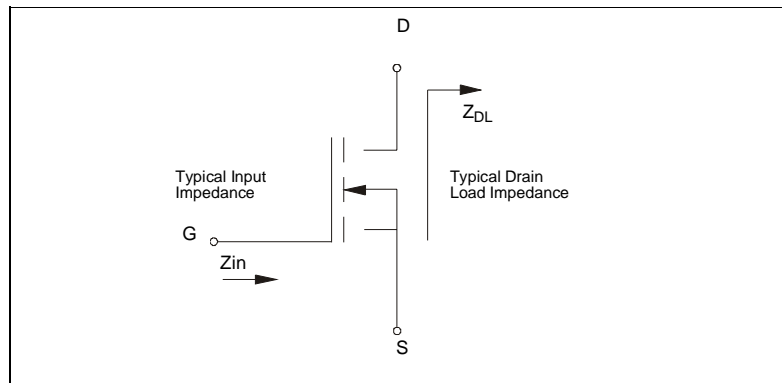

Table 7. Impedance Data

FREQ. MHz	$Z_{IN}(\Omega)$	$Z_{DL}(\Omega)$
480	$1.79 - j 4.96$	$10.68 + j 7.45$
500	$1.88 - j 5.93$	$10.28 + j 8.92$
520	$2.10 - j 7.03$	$9.86 + j 10.18$

## 2.1 Typical performances

Figure 2. Capacitance Vs supply Voltage

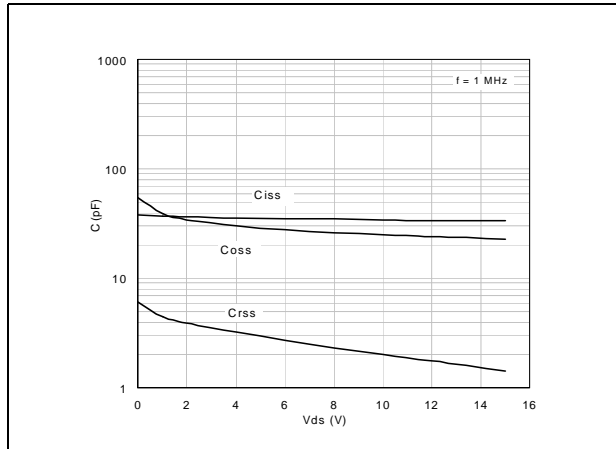

Figure 3. Output Power Vs Input Power

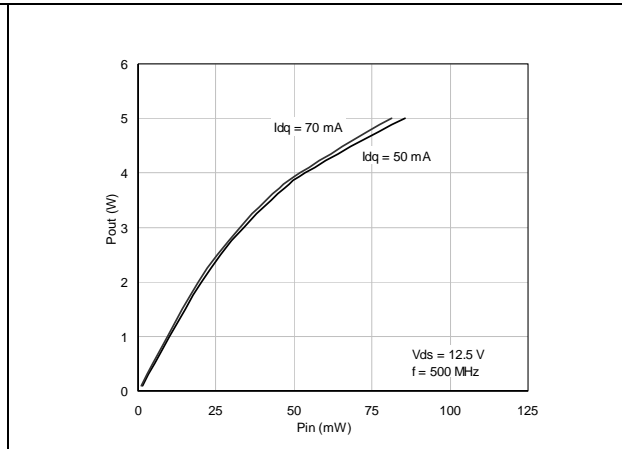

Figure 4. Power Gain Vs Output Power

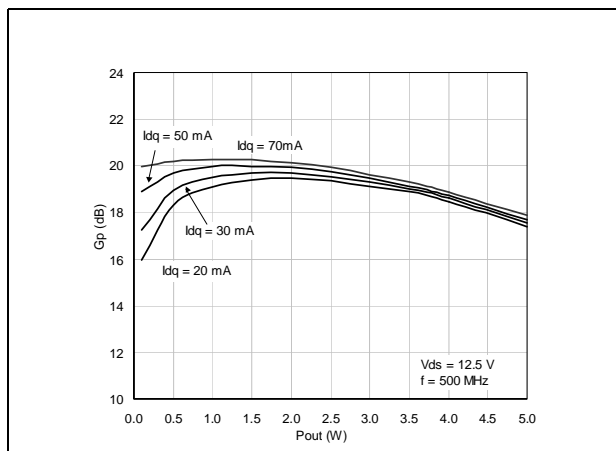

Figure 5. Efficiency Vs Output Power

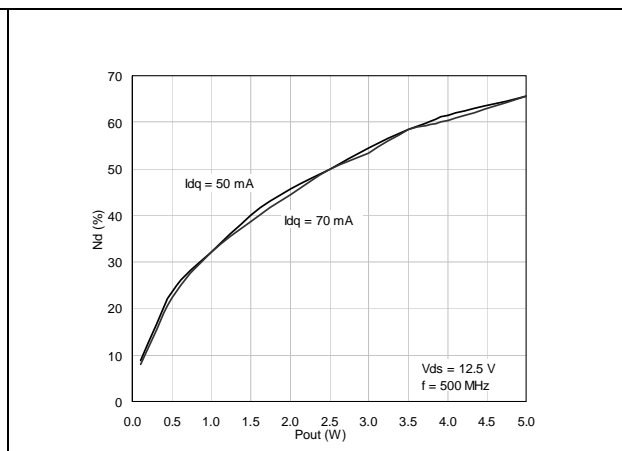

Figure 6. Input Return Loss Vs Output Power

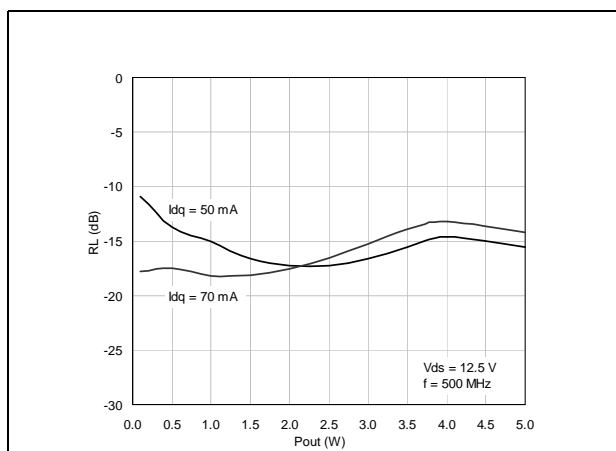

Figure 7. Output Power Vs Bias Current

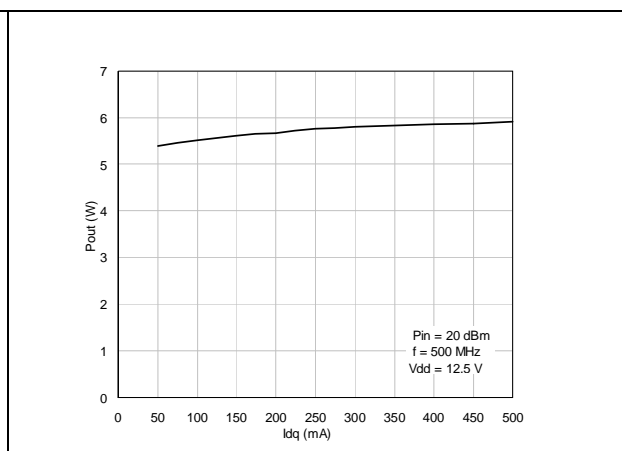

Figure 8. Efficiency Vs Bias Current

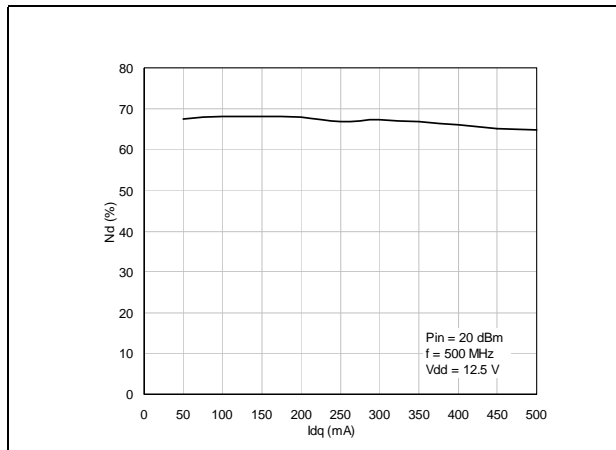

Figure 9. Output Power Vs Supply Voltage

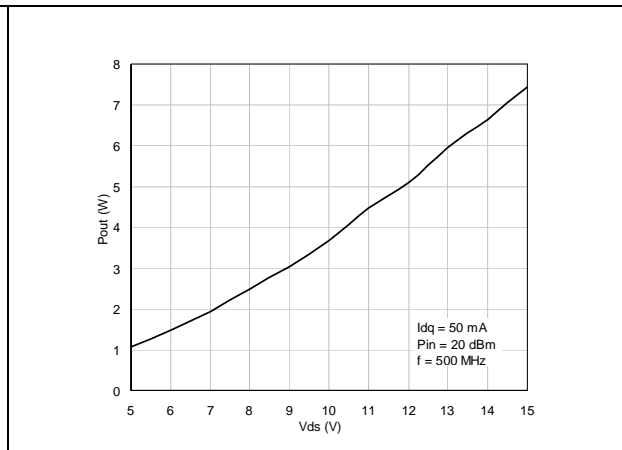
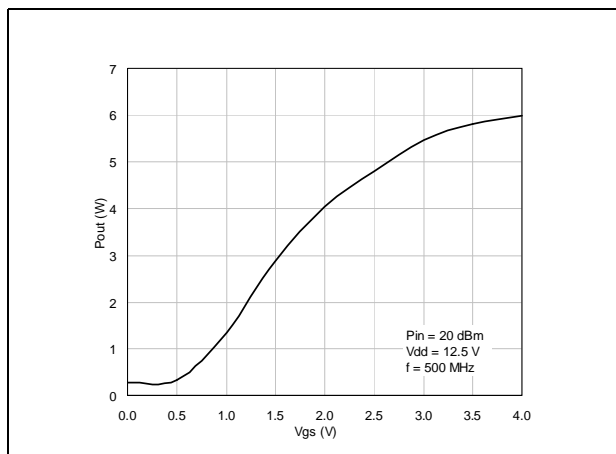

Figure 10. Output Power Vs Gate-Source Voltage



## 2.2 Typical performance (broadband)

Figure 11. Power Gain Vs Frequency

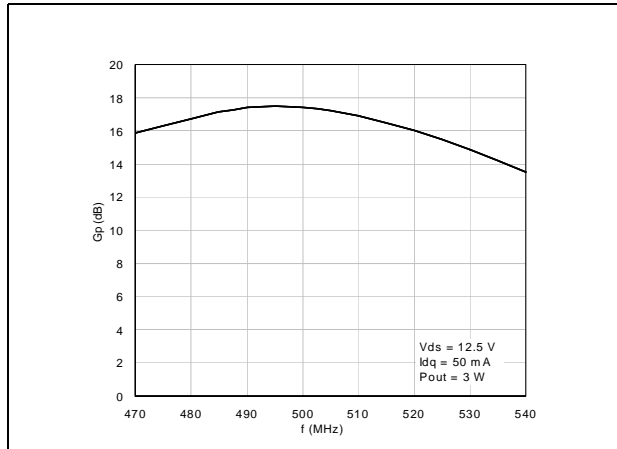

Figure 12. Efficiency Vs Frequency

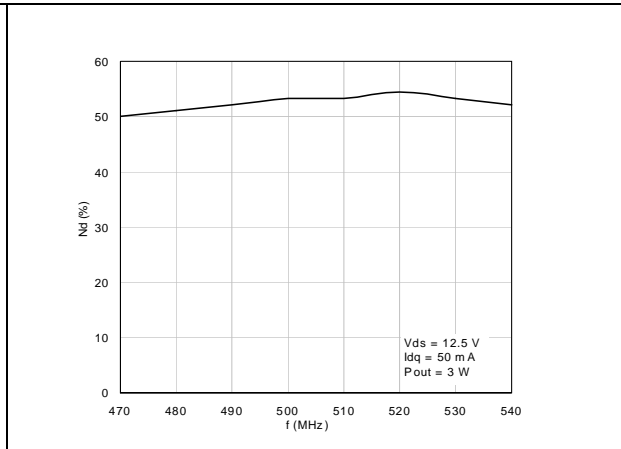
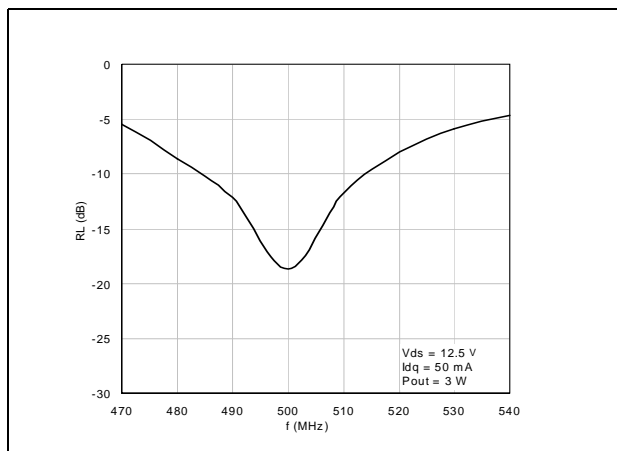
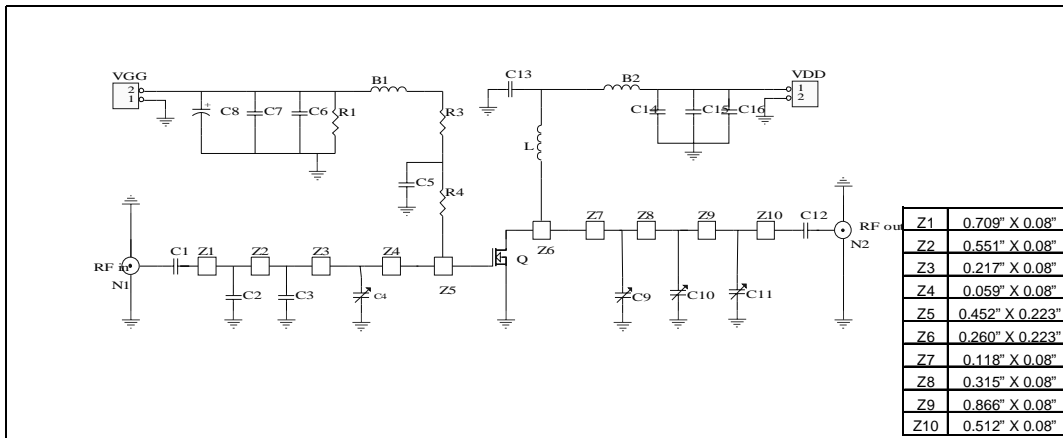

Figure 13. Return Loss Vs Frequency





### 3 Test circuit schematic



**Table 8. Test Circuit Component List**

Component	Description
B1, B2	FERRIDE BEAD
C1, C12	3000Pf, 100B ATC CHIP CAPACITOR
C2, C3	15pF, 100B ATC CHIP CAPACITOR
C4, C9	0 -:- 20 pF VARIABLE CAPACITOR JOHANSON
C5, C13	120pF 100B ACT CHIP CAPACITOR
C6, C14	0.1mF 100B ACT CAPACITOR
C7, C15	1200pF 100B ACT CAPACITOR
C8, C16	10μF, 35V, SMD ELECTROLYTIC CAPACITOR
C10	0.5 -:- 5pF VARIABLE CAPACITOR JOHANSON
C11	0.8 -:- 10pF VARIABLE CAPACITOR JOHANSON
R1	33KΩ CHIP RESISTOR 1W
R2, R3	15Ω MELF RESISTOR 1W
R4	1KΩ CHIP RESISTOR 1W
N1, N2	TYPE N FLANGE MOUNT
BOARD	ROGER ULTRA LAM 2000 THK 0.030" ε <sub>r</sub> = 2.55 2OZ ED Cu BOTH SIDES

### 3.1 Test Circuit

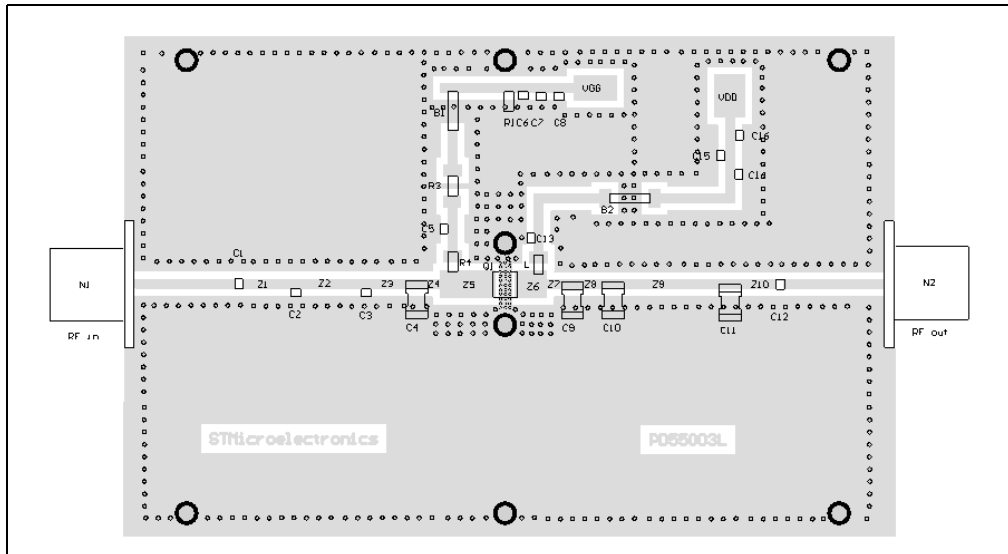

### 3.2 Test circuit photomaster

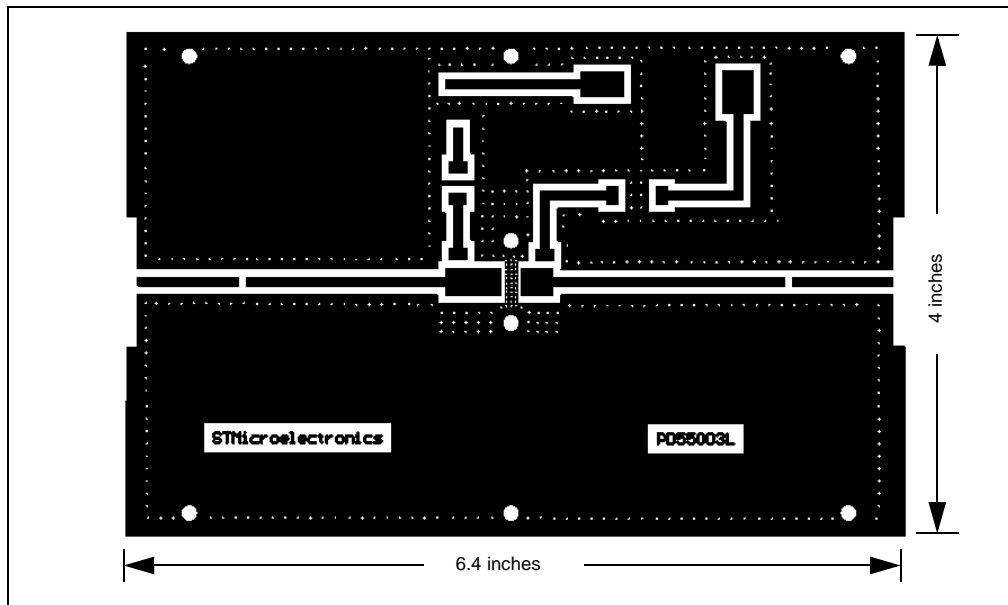

**Table 9. S-Parameter (PD55003L)** $(V_{DS}=12.5V, I_{DS}=0.15A)$ 

FREQ (MHz)	$ S_{11} $	$\angle S_{11}$	$ S_{21} $	$\angle S_{21}$	$ S_{12} $	$\angle S_{12}$	$ S_{22} $	$\angle S_{22}$
50	0.808	-110	20.14	112	0.039	22	0.672	-109
100	0.772	-141	11.77	93	0.042	5	0.633	-138
150	0.771	-152	7.86	82	0.041	-5	0.642	-147
200	0.779	-157	5.80	73	0.040	-11	0.665	-151
250	0.794	-161	4.50	66	0.038	-17	0.694	-154
300	0.809	-163	3.62	60	0.035	-22	0.721	-155
350	0.824	-165	2.98	54	0.033	-26	0.750	-157
400	0.839	-166	2.50	49	0.031	-30	0.774	-159
450	0.853	-168	2.13	44	0.028	-32	0.796	-160
500	0.865	-169	1.83	40	0.025	-34	0.818	-161
550	0.874	-171	1.59	36	0.023	-36	0.837	-163
600	0.885	-172	1.39	33	0.021	-36	0.852	-164
650	0.894	-173	1.23	29	0.018	-37	0.867	-165
700	0.901	-174	1.10	26	0.016	-37	0.880	-166
750	0.906	-175	0.97	23	0.015	-36	0.890	-167
800	0.911	-176	0.88	20	0.012	-32	0.902	-169
850	0.916	-177	0.79	18	0.011	-28	0.909	-169
900	0.918	-178	0.72	15	0.010	-22	0.918	-171
950	0.922	-179	0.65	13	0.008	-13	0.922	-171
1000	0.925	180	0.59	11	0.007	-7	0.928	-172
1050	0.925	179	0.54	9	0.007	8	0.934	-173
1100	0.928	178	0.50	7	0.006	21	0.938	-174
1150	0.927	177	0.46	5	0.007	38	0.941	-175
1200	0.928	176	0.43	4	0.008	51	0.944	-176
1250	0.929	175	0.40	2	0.010	56	0.947	-176
1300	0.927	175	0.37	1	0.011	61	0.953	-177
1350	0.927	174	0.34	-1	0.011	65	0.951	-178
1400	0.925	173	0.32	-2	0.012	68	0.952	-178
1450	0.922	172	0.30	-4	0.014	72	0.954	-179
1500	0.922	172	0.28	-5	0.016	73	0.957	-180

Table 10. S-Parameter (PD55003L)

 $(V_{DS}=12.5V, I_{DS}=0.8A)$ 

FREQ (MHz)	$ S_{11} $	$\angle S_{11}$	$ S_{21} $	$\angle S_{21}$	$ S_{12} $	$\angle S_{12}$	$ S_{22} $	$\angle S_{22}$
50	0.841	-124	22.20	107	0.029	21	0.651	-130
100	0.800	-150	12.84	92	0.031	6	0.654	-153
150	0.800	-159	8.59	83	0.031	-2	0.666	-159
200	0.803	-163	6.38	76	0.030	-8	0.684	-161
250	0.812	-166	5.00	70	0.028	-11	0.702	-163
300	0.822	-168	4.07	64	0.027	-15	0.721	-163
350	0.830	-169	3.39	59	0.025	-17	0.740	-164
400	0.837	-170	2.87	55	0.024	-20	0.760	-165
450	0.848	-172	2.47	50	0.022	-23	0.777	-166
500	0.857	-172	2.15	46	0.020	-23	0.795	-166
550	0.866	-174	1.89	42	0.018	-25	0.813	-167
600	0.874	-174	1.67	39	0.017	-23	0.825	-168
650	0.882	-175	1.49	35	0.015	-24	0.839	-168
700	0.887	-176	1.33	32	0.013	-22	0.853	-169
750	0.893	-177	1.19	29	0.012	-16	0.863	-170
800	0.898	-178	1.08	26	0.011	-15	0.875	-171
850	0.903	-179	0.98	23	0.010	-11	0.885	-172
900	0.904	-180	0.89	21	0.009	-1	0.893	-173
950	0.909	179	0.82	19	0.008	7	0.901	-173
1000	0.911	179	0.75	16	0.008	16	0.904	-174
1050	0.914	178	0.69	14	0.008	27	0.911	-175
1100	0.916	177	0.64	12	0.008	35	0.916	-175
1150	0.917	176	0.59	10	0.009	43	0.919	-176
1200	0.917	176	0.55	8	0.010	48	0.923	-177
1250	0.918	175	0.51	6	0.010	57	0.929	-177
1300	0.917	174	0.47	5	0.012	62	0.929	-178
1350	0.917	173	0.44	3	0.013	63	0.934	-179
1400	0.914	173	0.42	1	0.013	67	0.936	-179
1450	0.912	172	0.39	0	0.015	71	0.938	-180
1500	0.911	171	0.36	-2	0.016	72	0.941	179

Table 11. S-Parameter (PD55003L)

(V<sub>DS</sub>=12.5V, I<sub>DS</sub>=1.5A)

FREQ (MHz)	S <sub>11</sub>	∠S <sub>11</sub> (°)	S <sub>21</sub>	∠S <sub>21</sub> (°)	S <sub>12</sub>	∠S <sub>12</sub> (°)	S <sub>22</sub>	∠S <sub>22</sub> (°)
50	0.837	-114	18.43	111	0.030	24	0.588	-132
100	0.799	-143	10.49	93	0.033	6	0.632	-152
150	0.801	-154	6.99	82	0.032	-3	0.656	-158
200	0.809	-159	5.15	74	0.031	-9	0.680	-160
250	0.823	-163	4.00	67	0.029	-14	0.701	-162
300	0.835	-165	3.22	61	0.028	-18	0.726	-163
350	0.845	-167	2.66	56	0.025	-20	0.750	-164
400	0.855	-169	2.23	52	0.024	-24	0.768	-165
450	0.866	-170	1.91	47	0.022	-26	0.789	-166
500	0.876	-171	1.65	43	0.020	-24	0.812	-167
550	0.882	-173	1.44	39	0.018	-25	0.828	-167
600	0.892	-174	1.26	36	0.016	-25	0.836	-168
650	0.898	-175	1.12	33	0.015	-25	0.844	-169
700	0.903	-176	1.00	29	0.013	-20	0.857	-170
750	0.907	-177	0.90	27	0.011	-17	0.868	-171
800	0.909	-178	0.81	24	0.010	-10	0.883	-171
850	0.912	-179	0.73	21	0.009	-6	0.889	-172
900	0.915	-180	0.67	19	0.009	1	0.894	-173
950	0.917	179	0.61	17	0.008	17	0.905	-174
1000	0.917	178	0.56	15	0.008	24	0.907	-174
1050	0.918	178	0.51	13	0.008	32	0.908	-175
1100	0.920	177	0.47	11	0.009	40	0.912	-176
1150	0.920	176	0.44	9	0.010	48	0.919	-177
1200	0.920	175	0.41	7	0.010	57	0.922	-177
1250	0.919	174	0.38	6	0.012	59	0.926	-178
1300	0.919	174	0.35	4	0.013	61	0.931	-179
1350	0.918	173	0.33	3	0.014	63	0.928	-179
1400	0.917	172	0.31	1	0.015	68	0.929	-180
1450	0.914	172	0.29	0	0.016	70	0.933	180
1500	0.912	171	0.27	-1	0.018	71	0.935	179

## 4 Package mechanical data

In order to meet environmental requirements, ST offers these devices in ECOPACK® packages. These packages have a Lead-free second level interconnect . The category of second level interconnect is marked on the package and on the inner box label, in compliance with JEDEC Standard JESD97. The maximum ratings related to soldering conditions are also marked on the inner box label. ECOPACK is an ST trademark. ECOPACK specifications are available at: [www.st.com](http://www.st.com)

Table 12. PowerFLAT™ Mechanical Data

Dim.	mm			inch		
	MIN.	TYP.	MAX.	MIN.	TYP.	MAX.
A		0.90	1.00		0.035	0.039
A1		0.02	0.05		0.001	0.002
A3		0.24			0.009	
AA	0.15	0.25	0.35	0.006	0.01	0.014
b	0.43	0.51	0.58	0.017	0.020	0.023
c	0.64	0.71	0.79	0.025	0.028	0.031
D		5.00			0.197	
d		0.30			0.011	
E		5.00			0.197	
E2	2.49	2.57	2.64	0.098	0.101	0.104
e		1.27			0.050	
f		3.37			0.132	
g		0.74			0.03	
h		0.21			0.008	

Figure 14. PowerFLAT™ Package Dimensions

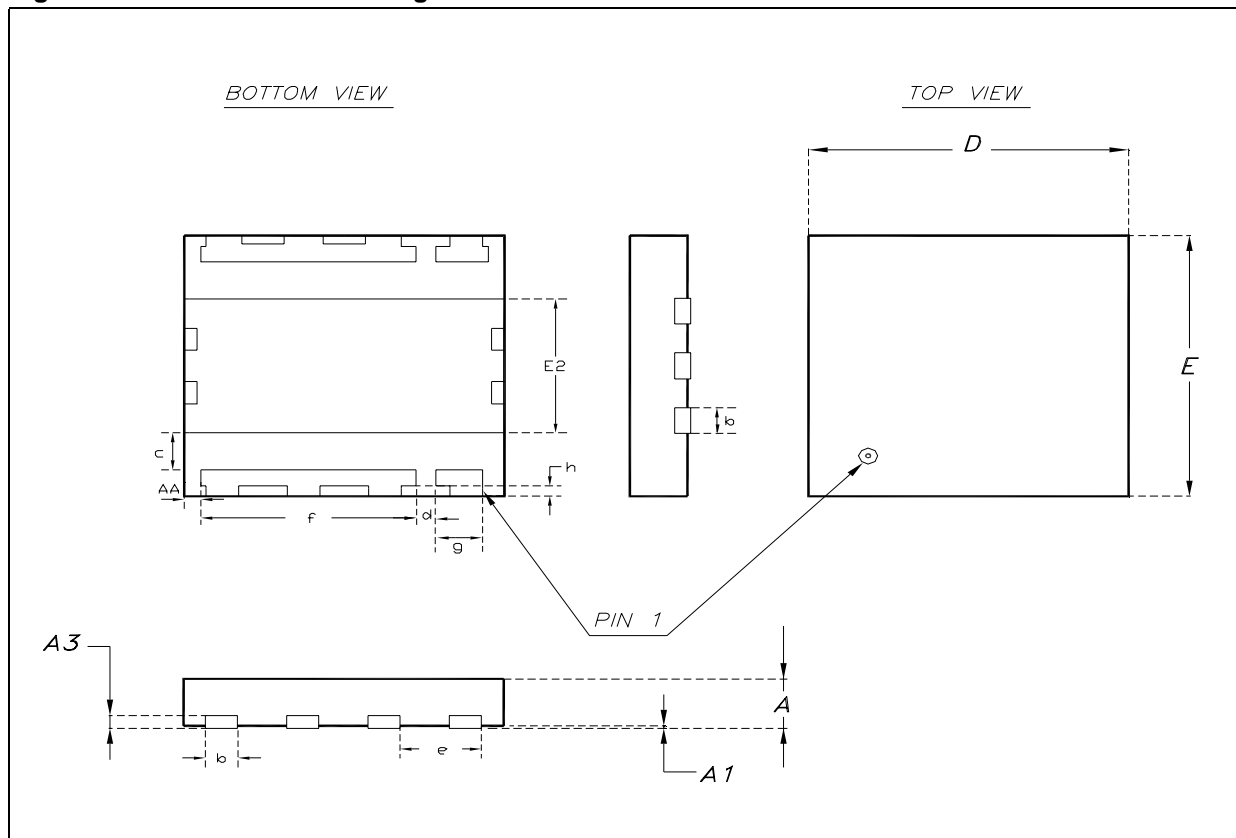

Table 13. PowerFLAT™ Tape & Reel Dimensions

DIM.	mm.		
	MIN.	TYP	MAX.
Ao	5.15	5.25	5.35
Bo	5.15	5.25	5.35
Ko	1.0	1.1	1.2

Figure 15. PowerFLAT™ Tape & Reel

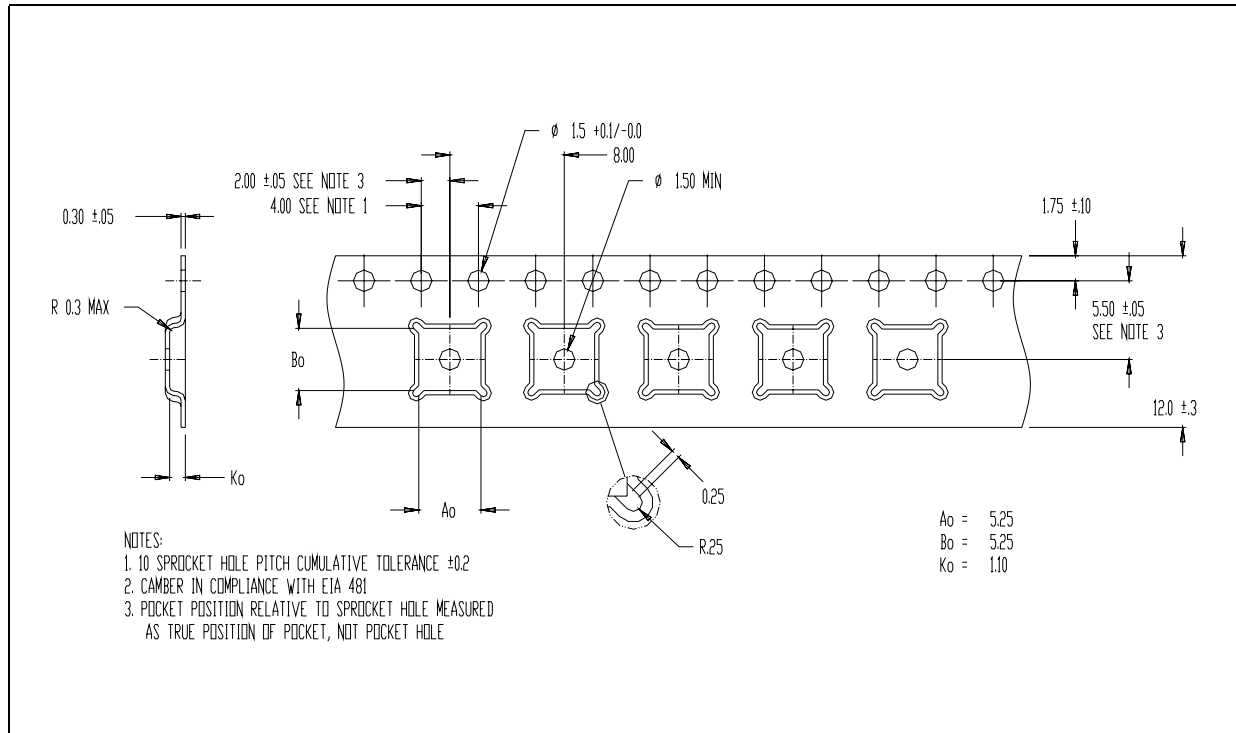
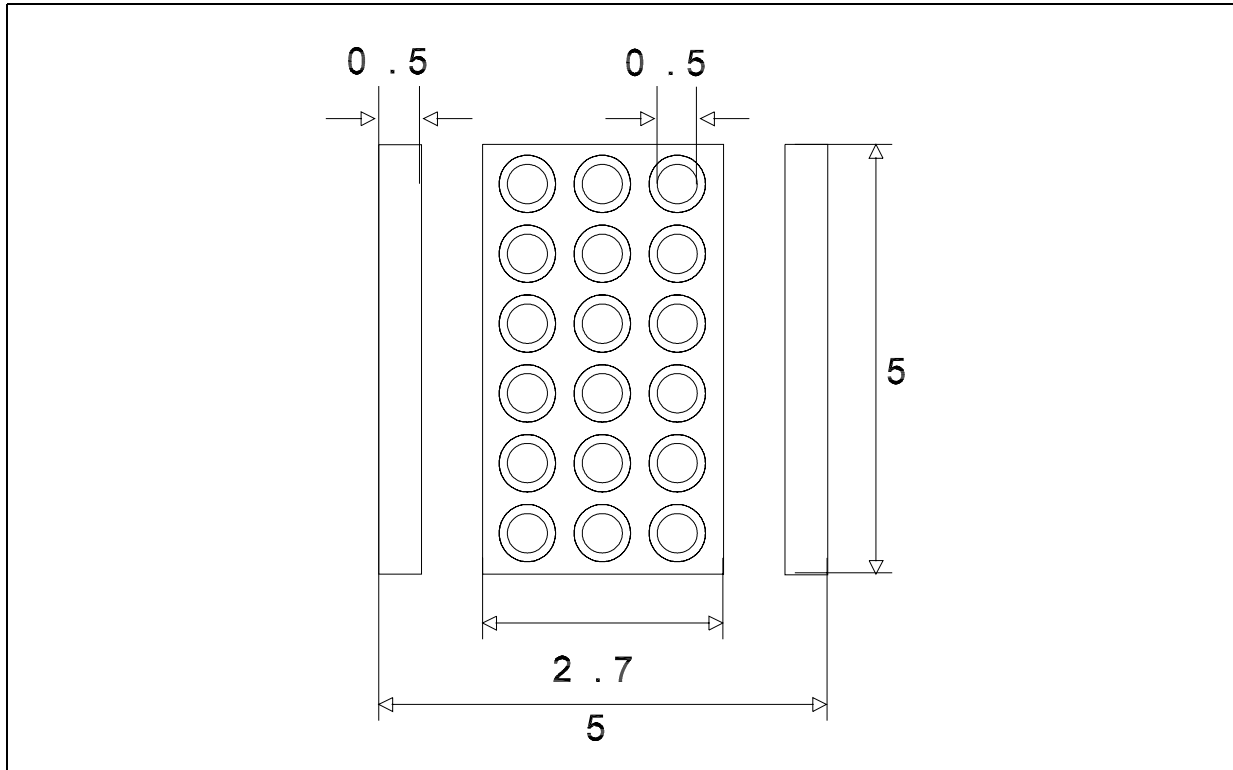



Table 14. Recommended FOOTPRINT



## 5 Revision history

Table 15. Document revision history

Date	Revision	Changes
14-Feb-2006	1	First Issue

Information furnished is believed to be accurate and reliable. However, STMicroelectronics assumes no responsibility for the consequences of use of such information nor for any infringement of patents or other rights of third parties which may result from its use. No license is granted by implication or otherwise under any patent or patent rights of STMicroelectronics. Specifications mentioned in this publication are subject to change without notice. This publication supersedes and replaces all information previously supplied. STMicroelectronics products are not authorized for use as critical components in life support devices or systems without express written approval of STMicroelectronics.

The ST logo is a registered trademark of STMicroelectronics.  
All other names are the property of their respective owners

© 2006 STMicroelectronics - All rights reserved

STMicroelectronics group of companies

Australia - Belgium - Brazil - Canada - China - Czech Republic - Finland - France - Germany - Hong Kong - India - Israel - Italy - Japan -  
Malaysia - Malta - Morocco - Singapore - Spain - Sweden - Switzerland - United Kingdom - United States of America

[www.st.com](http://www.st.com)